

Investigation of Gamma Ray Buildup Factor for some Shielding Absorber

Hiwa Mohammad Qadr^{1,a,*}¹ Department of Physics, College of Science, University of Raparin, Sulaimanyah, Iraq.

*Corresponding author



Research Article

History

Received: 04/04/2022

Accepted: 06/08/2022

Copyright

©2022 Faculty of Science,
Sivas Cumhuriyet University hiwa.physics@uor.edu.krd <https://orcid.org/0000-0001-5585-3260>

ABSTRACT

The purpose of this research is to observe and understand the processes by which gamma rays are attenuated in passing through absorber, and the effects of shielding geometry. Gamma ray linear attenuation coefficient, mass attenuation coefficient, mean free path, half value layer and buildup factor were evaluated for different absorbers, by using ⁶⁰Co source with energy value 1.332 MeV. The linear attenuation coefficient of the absorber such as aluminium was (0.1485 cm⁻¹), whereas it was observed (0.4359 cm⁻¹) for iron, and stainless steel was (0.463 cm⁻¹). The obtained results have been compared to the other absorbers. As a result of that, linear attenuation coefficient and the mass attenuation coefficient are higher for stainless steel and better radiation shielding compared with other absorbers. The results of theoretical and experimental for all parameters are a good agreement. Moreover, it is found that the buildup factor increases with thickness of the absorber increasing.

Keywords: Scintillation detector, Shielding absorber, Buildup factor, Broad-beam geometry, Mean free path.

Introduction

There are two main types of ionizing radiation. First, the directly ionizing radiations such as the alpha particle, beta particles and many other charged particles ionize atoms of their target material due to coulombic interactions with the electrons of the material, and the amount of kinetic energies of these particles determines the amount of this coulombic force [1-5]. Second, indirectly ionizing radiations are neutral particles such as high energy photons and neutrons which do not directly ionize atoms but undergo interactions to eject an energetic electron called the secondary electron. Despite the fact that a large number of possible interaction mechanisms of gamma rays with matter are known, three processes are most important in the attenuation of gamma rays by matter [6-9]. These processes of interaction are photoelectric effect, Compton scattering and pair production. In each of these processes an ionizing particle, usually an electron, is produced which can subsequently be detected. Photoelectric interactions are dominate at low energies (up to several hundred keV) and pair production at high energies (more than 5 MeV) with Compton scattering being most important in the mid-energy range [10-12]. Compton scattering refers to an inelastic scatter between a photon and a particle (usually electron). When an incident photon of relative high energy comes to interact with an atom, the bond between electron and nuclei is weak, indicating that we can regard the electron as nearly free and use the Compton scattering model [13-15].

Nowadays, there are a large number of experimental, theoretical and simulation studies have been applied on the absorbed dose and radiation shielding parameters in different ways [16-24]. Therefore, the linear attenuation

coefficient, the mass attenuation coefficient, Half Value Layer, Tenth Value Layer and Mean Free Path are a useful parameters that must be known to design and choose a shielding material. Furthermore, gamma ray buildup factor is a useful parameter for calculating radiation shielding, absorbed dose and protection, have been usually studied by practical measurements and theoretical calculation [25-28].

In this research, ⁶⁰Co source used in this work should be transported in its carrying brick, always handle remotely and requires appropriate shielding to reduce the dose rate at all exposed areas to less than 2.5 mSv/hr [6]. The linear attenuation coefficient and gamma ray buildup factors were determined for three shielding absorbers. Then, obtained values of the parameters compared with the theoretical values.

Theoretical Calculation

This section summarize theoretical relations which have been used for the determination linear attenuation coefficient μ , mass attenuation coefficient μ_m , half value layer HVL, mean free path MFP and buildup factor B. Basically, According to Lambert-Beer's law, gamma rays are attenuated passing through an absorber [18]. Probability, some of the gamma rays travel through the thickness without interaction leading to the transmission of the gamma rays. The intensity of the transmitted beam at any thickness of the absorber can be described in the following equation:

$$I = I_0 e^{-\mu x} \quad (1)$$

Where μ , cm⁻¹ is the linear attenuation coefficient of the absorber. I_0 is the initial intensity of the gamma ray, I is transmitted intensity of the gamma ray and x , cm is thickness. Rearrange of equation (1) gives the following equation for linear attenuation coefficient.

$$\mu = \frac{1}{x} \ln \left(\frac{I_0}{I} \right) \quad (2)$$

The linear attenuation coefficient is the sum of the contributions to attenuation coefficient for each type of interaction, as [10];

$$\mu = \mu_{ph} + \mu_C + \mu_P \quad (3)$$

Here μ_{ph} , μ_C and μ_P denote photoelectric absorption, Compton scattering and pair production, respectively.

Mass attenuation coefficient can be described as a ratio of the linear attenuation coefficient to unit density (ρ) of the absorber with unit (cm²/g) [29]. It can be a useful coefficient due to only the atomic composition of the attenuator is taken into account and not the individual density of the absorber. Thus, using equation (4), mass attenuation coefficient from linear attenuation coefficient can be calculated as:

$$\mu_m = \frac{(\mu)}{(\rho)} \quad (4)$$

The half value layer (HVL) with unit cm is also called the half value thickness. It can be defined as the thickness of the absorber at which the transmitted intensity is one-half the incident intensity for the gamma ray [30, 31]. The HVL depends on the linear attenuation coefficient values and can be calculated by the following formula:

$$HVL = \frac{\ln 2}{\mu} \quad (5)$$

The linear attenuation coefficient is inversely related to mean free path (MFP) which is the average distance between two successive collisions during gamma ray travels in matter [32], it can be expressed as:

$$MFP = \frac{1}{\mu} \quad (6)$$

Buildup factor (B) is a useful parameter that shows the ratio of the total radiation quantity at a given point to the number un-collided photons [33]. So, this parameter depends on energy of the photon, linear attenuation and thickness of the absorber. The schematic arrangement of the narrow-beam geometry is shown in figure (1). It shows the thickness of the absorber which placed between the source and the detector. In this circumstance, the detector is able to detect only those photons that suffers no collision with the absorber. The narrow-beam geometry can be expressed in the following expression.

$$\frac{I_{good}}{I_0} = e^{-\mu x} \quad (7)$$

Figure 2 shows broad- beam geometry which scattered photons in the absorber are able to reach the detector. The broad-beam geometry can be written in the following expression.

$$\frac{I_{bad}}{I_0} = e^{-\mu x} \quad (8)$$

Hence, based on equations 6 and 7, the buildup factor can be calculated in the following relation [34].

$$B = \frac{I_{bad \text{ geometry}}}{I_{good \text{ geometry}}} \quad (9)$$

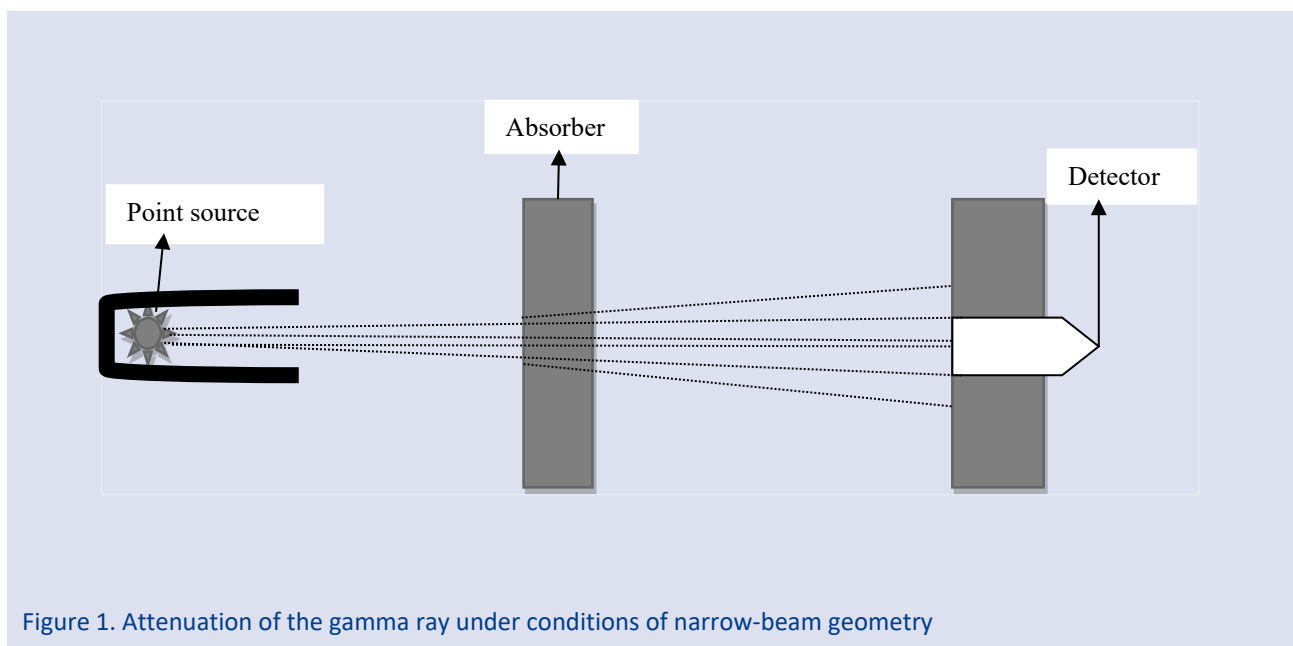

Figure 1. Attenuation of the gamma ray under conditions of narrow-beam geometry

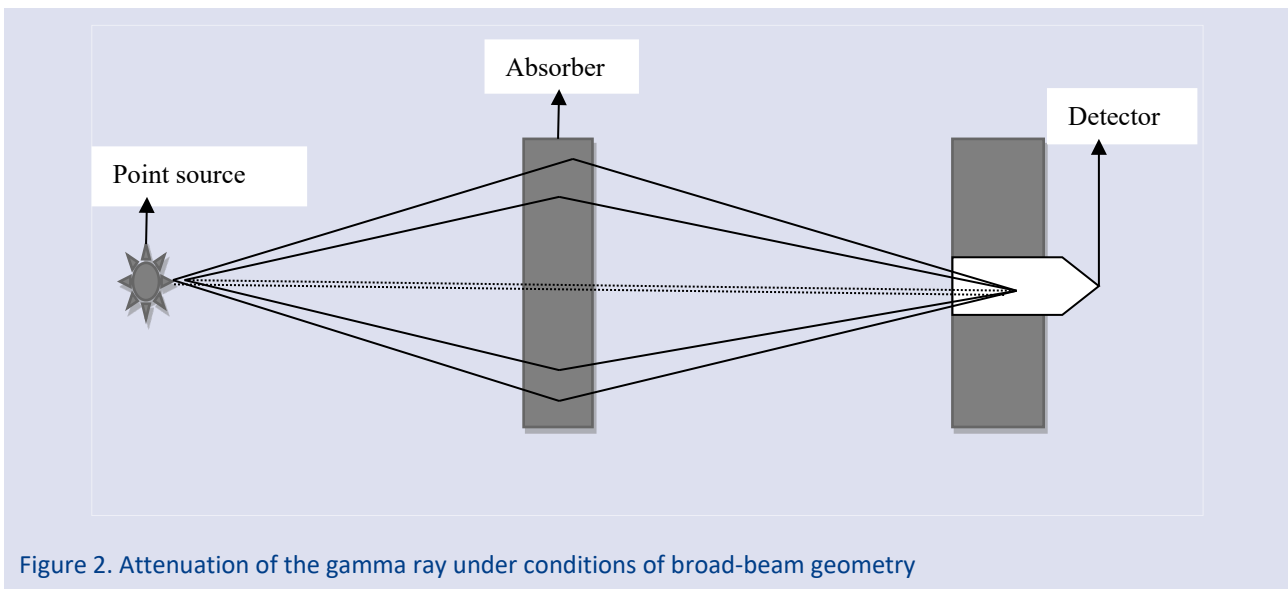

Figure 2. Attenuation of the gamma ray under conditions of broad-beam geometry

Methodology

Figure 3 shows schematic picture for the electric system which used in this paper. The absorbers used as shield are iron, concrete and aluminium. Start by building a well shielded enclosure and inserting the 7 MBq ^{60}Co source at one end. The radioactive source emits gamma rays with energies value 1.332 MeV. The energy spectra in this work obtained from NaI(Tl) scintillation detector were analyzed by the maestro program. Place absorber between the source and the detector, and measure gamma ray attenuation versus absorber thickness.

Buildup factor is measured by two methods. First, for narrow-beam geometry, the distance between the point source and the absorber was 14 cm and the distance between the detector and the point source is 47 cm. At

the beginning, an initial measurement was recorded without using any absorber. Then, this step was repeated for different thickness of the absorber and Data acquisition time was chosen as 120 seconds for each shielding absorber. As a result of that, only those gamma rays are allowed to reach the detector which traverse the absorber without undergoing any collision.

Second, for broad-beam geometry, the distance between the point source and the detector was increased in which scattered gamma rays in the thickness absorber are also able to reach the detector after collisions. So, using different absorber in both narrow-beam and broad-beam geometry, we can count number of gamma rays passed through these absorbers for various absorber thickness.

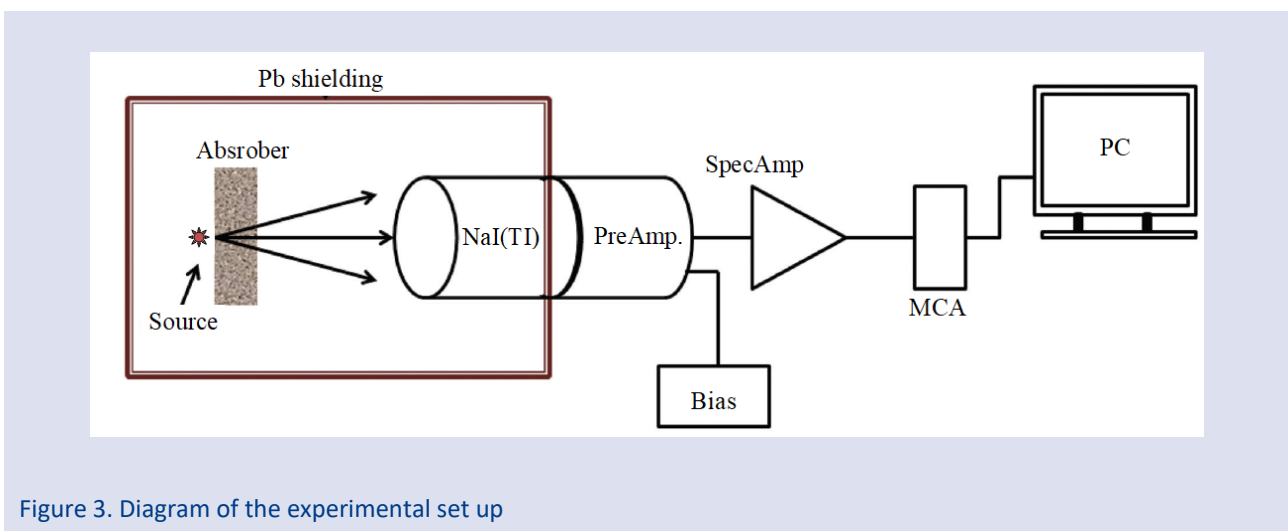

Figure 3. Diagram of the experimental set up

Results and Analysis

Calculation of the gamma ray attenuation coefficient for aluminium, iron and stainless steel are carried out using both narrow-beam and broad-beam geometries to calculate $\ln(I/I_0)$. Figures 4 obviously shows the $\ln(I/I_0)$ as

functions of the absorber thickness for both narrow-beam and broad-beam geometrical arrangement using ^{60}Co source

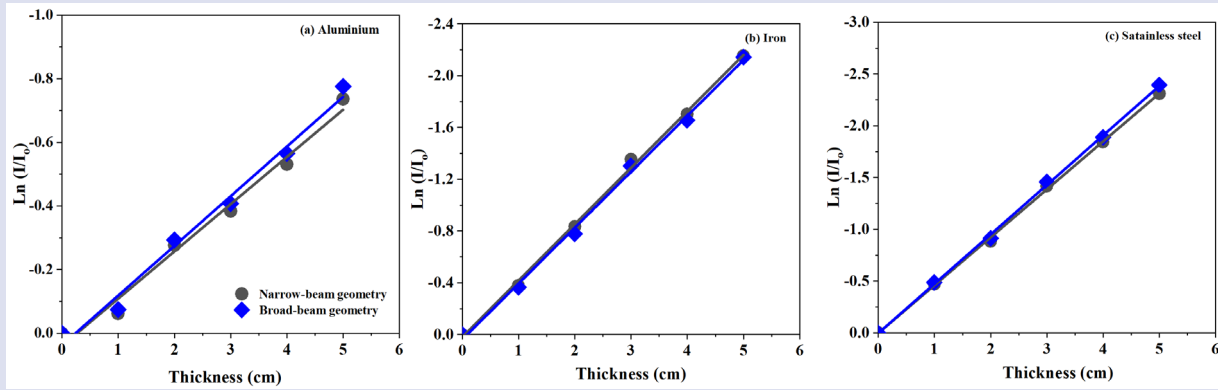

Figure 4. Comparison $\ln(I/I_0)$ as a function of the absorber thickness for both narrow-beam and broad-beam geometries using (a) aluminium (b) iron (c) stainless steel

Table 1 demonstrates the experimental values of the gamma ray linear and mass attenuation coefficients for three types shielding absorber. They were obtained by measuring the intensities of gamma rays passed through the various absorbers. It is evident from this table the linear and mass attenuation coefficient for aluminum has the lowest value, and for stainless steel it is the highest. The highest linear and mass attenuation coefficient are

due to its containment of high atomic number and high density that are more effective for gamma ray attenuation. On other hand, the lowest values of the linear and mass attenuation coefficient indicate higher penetration depth. The experimental μ and μ_m values were compared the theoretical μ and μ_m values [35, 36]. It is clearly demonstrate that the experimental results agree with the theoretical values

Table 1. Values of the experimental and theoretical linear and mass attenuation coefficient for three types shielding absorber.

Source	Atomic number	ρ (g/cm ³)	Experimental μ (cm ⁻¹)	Theoretical μ (cm ⁻¹)	Experimental μ_m (cm ² /g)	Theoretical μ_m (cm ² /g)
Aluminium	13	2.74	0.1485	0.137	0.0542	0.052
Iron	26	7.86	0.4359	0.421	0.0554	0.0535
Stainless steel	28	7.9	0.463	0.462	0.0586	0.0585

Another parameters measured in this work for the gamma ray interaction with absorbers are half value layers and mean free path. The experimental and theoretical gamma ray half value layers and mean free path of shielding absorbers are shown in Table 2. It is clear that the stainless steel has the lowest values of both half

value layer and mean free path. While, aluminium has the highest value of both parameters due to it is has poor atomic number. It is also showed that the experimental results and theoretical values for both parameters are a good agreement.

Table 2. Values of the experimental and theoretical half value layer and mean free path for three types shielding absorber

Source	Experimental HVL (cm)	Theoretical HVL (cm)	Experimental MFP (cm)	Theoretical MFP (cm)
Aluminium	4.668	5.059	6.734	7.299
Iron	1.59	1.646	2.294	2.475
Stainless steel	1.497	1.5003	2.16	2.1645

Buildup factor is also useful parameter in designing any radiation shielding. Buildup factor of shielding absorbers are measured using narrow-beam and broad-beam geometry and are given in Table 3. It is observed that as the thickness shielding absorber increases, the buildup factor increases. Hence, buildup factor values rely on the atomic number.

Nevertheless, the table indicates that broad-beam geometry values are bigger than narrow-beam geometry values due to there are no scattered gamma rays for narrow-beam geometry. Figure 5 shows comparison buildup factor as a function of penetration depth.

Table 3. Values of broad-beam geometry and narrow-beam geometry and buildup factor for three shielding absorber

Source	Thickness (cm)	Broad-beam geometry	Narrow-beam geometry	Buildup factor
Aluminium	0	292.6033	148.7733	1
	1	271.67	127.87	1.080236367
	2	218.1233	100.89	1.0992582
	3	194.675	86.34	1.146420427
	4	166.3867	73.53	1.150534958
	5	134.6722	54.226	1.262746466
Iron	0	351.18	195.9067	1
	1	236.7533	122.53667	1.07782805
	2	149.25	76.34	1.090640696
	3	88.31667	43.49667	1.132677283
	4	62.11333	30.5	1.136068422
	5	39.155	17.41	1.254607767
Stainless steel	0	323.09	189.677	1
	1	198.89	109.5433	1.06590447
	2	129.75	70.436	1.081443507
	3	75.22	39.928	1.10597912
	4	48.91	25.433	1.128992943
	5	30.65	14.96	1.202790644

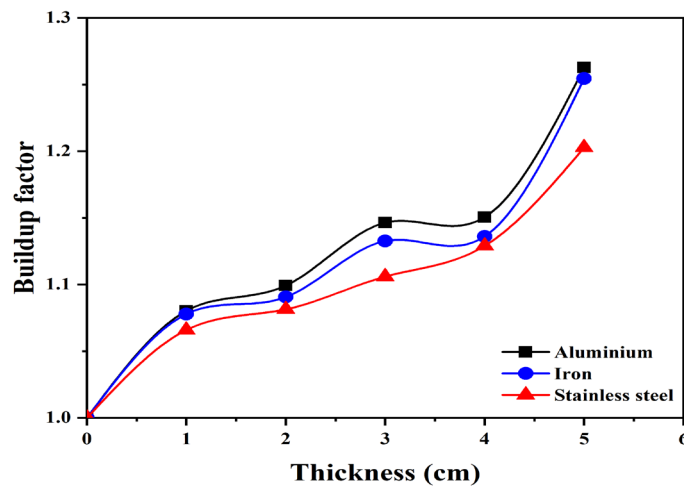

Figure 5. Buildup factor as a function of absorber thickness for aluminium, iron and stainless steel

Conclusion

In this paper, gamma ray attenuation parameters of three types shielding absorbers have been investigated and discussed in terms of gamma ray attenuation coefficient and buildup factor at 1.332 MeV energy. The result shows that the linear and mass attenuation coefficient decrease with increasing atomic number and density of the absorber. Thus, stainless steel appears to be the best gamma ray absorber among the three absorbers under consideration due to its higher value for linear and mass attenuation coefficient. The results of HVL, and MFP were also determined for three absorbers. Clearly, aluminium absorber has the highest value of the above

parameters and stainless steel absorber has the lowest values. The lower HVL and MFP values of any shielding absorber are better for shielding purposes.

Furthermore, the data shows that broad-beam geometry values are always greater than narrow-beam geometry values. It is noticed that the buildup factor for aluminium has higher value due to it has a lower atomic number compared to other absorbers. So, it is easy for gamma ray to scatter and pass through this absorber.

Conflicts of interest

The authors state that did not have conflict of interests

References

- [1] Qadr, H. M., Pressure Effects on Stopping Power of Alpha Particles in Argon Gas, *Physics of Particles and Nuclei Letters*, 18(2) (2021) 185-189.
- [2] Hiwa, M. Q., Stopping power of alpha particles in helium gas, Bulletin of the Moscow State Technical University. NE Bauman. Series "Natural Sciences", (2) (2020) 117-125.
- [3] Qadr, H. M., Hamad, A. M., Using of Stopping and Range of Ions in Matter Code to Study of Radiation Damage in Materials, *RENSIT* 12(4) (2020) 451-456.
- [4] Qadr, H. M., A molecular dynamics calculation to cascade damage processes, The Annals of "Dunarea de Jos" University of Galati. Fascicle IX, *Metallurgy and Materials Science*, 43(4) (2020) 13-16.
- [5] Mohammad, Q., Maghdid, H., Alpha-particle stopping powers in air and argon, *Journal of pure and applied physics*, 5 (2017) 22-28.
- [6] Knoll, G. F., Radiation detection and measurement, John Wiley & Sons 2010.
- [7] Sengupta, B., Generation and Modeling of Radiation for Clinical and Research Applications, (2019).
- [8] Qadr, H. M., Proportional Counter in X-Ray Fluorescence, *Aksaray University Journal of Science and Engineering*, 5(1) (2021) 1-7.
- [9] Qadr, H. M., Mamand, D., A Review on DPA for computing radiation damage simulation, *Journal of Physical Chemistry and Functional Materials*, 5(1) (2022) 30-36.
- [10] Hamad, A. M., Qadr, H. M., Gamma-Rays Spectroscopy by Using a Thallium Activated Sodium Iodide NaI (TI), *Eurasian Journal of Science and Engineering*, 4(1) (2018) 99-111.
- [11] Qadr, H. M., Comparison of energy resolution and efficiency of NaI (TI) and HPGe detector using gamma-ray spectroscopy, *Journal of Physical Chemistry and Functional Materials*, 3(1) (2020) 24-27.
- [12] Parks, J. E., The Compton effect-Compton scattering and gamma ray spectroscopy, Department of Physics, University of Tennessee, Knoxville, TN (2009) 37.
- [13] Bergstrom Jr, P., Surić, T., Pisk, K., Pratt, R., Compton scattering of photons from bound electrons: full relativistic independent-particle-approximation calculations, *Physical Review A*, 48(2) (1993) 1134.
- [14] Xiong, M., Activity Estimation Method of Linear Gamma-Ray Source under Shield Based on Single Compton Scattering, *Open Access Library Journal*, 7(07) (2020) 1.
- [15] Qadr, H. M., Experimental Study of the Pressure Effects on Stopping Power for Alpha Particles in Air, *Gazi University Journal of Science*, (2022) 272-279.
- [16] Qadr, H., Effect of Ion Irradiation on the Mechanical Properties of High and Low Copper, *Atom Indonesia*, 46(1) (2020) 47-51.
- [17] Tekin, H. O., Manici, T., Simulations of mass attenuation coefficients for shielding materials using the MCNP-X code, *Nuclear Science and Techniques*, 28(7) (2017) 1-4.
- [18] Alavian, H., Tavakoli-Anbaran, H., Comparative study of mass attenuation coefficients for LDPE/metal oxide composites by Monte Carlo simulations, *The European Physical Journal Plus*, 135(1) (2020) 82.
- [19] Sayyed, M., Agar, O., Kumar, A., Tekin, H., Gaikwad, D., Obaid, S. S., Shielding behaviour of $(20+x)$ Bi₂O₃-20BaO-10Na₂O-10MgO-(40-x) B₂O₃: an experimental and Monte Carlo study, *Chemical Physics*, 529 (2020) 110571.
- [20] Hiwa, M. Q., The use of the MCNP Code for Radiation Damage Calculations, *Mathematical Physics and Computer Modeling*, 24(1) (2021).
- [21] Qadr, H. M., Radiation damage and dpa in iron using mcnp5, *European Journal of Materials Science and Engineering*, 5(3) (2020) 109-114.
- [22] Qadr, H. M., Mamand, D. M., Molecular Structure and Density Functional Theory Investigation Corrosion Inhibitors of Some Oxadiazoles, *Journal of Bio- and Tribo-Corrosion*, 7(4) (2021) 140.
- [23] Qadr, H. M., A Molecular Dynamics Study of Temperature Dependence of the Primary State of Cascade Damage Processes, *Russian Journal of Non-Ferrous Metals* 62(5) (2021) 561-567.
- [24] Qadr, H. M., Hamad, A. M., MECHANICAL PROPERTIES OF FERRITIC MARTENSITIC STEELS: A REVIEW, Scientific Bulletin of 'Valahia' University, *Materials & Mechanics*, 17(16) (2019).
- [25] Susoy, G., Guclu, E. A., Kilicoglu, O., Kamislioglu, M., Al-Buriahi, M., Abuzaid, M., Tekin, H., The impact of Cr₂O₃ additive on nuclear radiation shielding properties of LiF-SrO-B₂O₃ glass system, *Materials Chemistry and Physics* 242 (2020) 122481.
- [26] Kurudirek, M., Kurucu, Y., Investigation of some nuclear engineering materials in terms of gamma ray buildup factors at experimental energies used in nuclear physics experiments, *Radiation Effects and Defects in Solids* (2020) 1-17.
- [27] Manić, V., Manić, G., Nikezić, D., Krstić, D., Effect of Buildup Factors on Indoor Gamma Dose Rate, *Radiation Protection Dosimetry* (2020).
- [28] Sriwongsa, K., Coconut dust gypsums board for shielding radiation and buildup factors building material, *Walailak Journal of Science and Technology (WJST)* (2020).
- [29] Akman, F., Enez, B., Fincan, S. A., Akdemir, F., Geçibesler, I., Investigation of some radiation interaction parameters for bacteria isolated from the soil in the low energy region, *Canadian Journal of Physics*, 98(3) (2020) 251-259.
- [30] Alim, B., A comprehensive study on radiation shielding characteristics of Tin-Silver, Manganin-R, Hastelloy-B, Hastelloy-X and Dilver-P alloys, *Applied Physics A*, 126(4) (2020) 1-19.
- [31] Akkaş, A., Determination of the tenth and half value layer thickness of concretes with different densities, *Acta Physica Polonica, A* 129(4) (2016) 770-772.
- [32] Qadr, H. M., Calculation of gamma-ray attenuation parameters for aluminium, iron, zirconium and tungsten, *Problems of Atomic Science and Technology, Ser. Thermonuclear Fusion*, 43(2) (2020) 25-30.
- [33] Jubair, S., Calculation of the Buildup Factors for Ceramic Materials, *Iraqi Journal of Applied Physics*, 7(1) (2011) 23-26.
- [34] Qadr, H. M., Calculation for gamma ray buildup factor for aluminium, graphite and lead, *International Journal of Nuclear Energy Science and Technology*, 13(1) (2019) 61-69.
- [35] Hubbell, J. H., Seltzer, S. M., Tables of X-ray mass attenuation coefficients and mass energy-absorption coefficients 1 keV to 20 MeV for elements Z= 1 to 92 and 48 additional substances of dosimetric interest, National Inst. of Standards and Technology-PL, Gaithersburg, MD (United ..., 1995).
- [36] Hubbell, J., Photon cross sections, attenuation coefficients and energy absorption coefficients, National Bureau of Standards Report NSRDS-NBS29, Washington DC (1969).